

# CONNETTORI PER SENSORI CONNECTORS FOR SENSORS



⇒ VERSIONI TIPO ELETTROVALVOLA E VERSIONI M12 NON CABLATE

⇒ VERSIONI NEUTRE E CON LED

⇒ WIDE RANGE OF M12 AND ELECTRO-SOLENOID TYPE CONNECTORS WIRELESS

⇒ NEUTRAL AND WITH LED VERSIONS

## COME ORDINARE

## HOW TO ORDER

### VERSIONE/ VERSIONS

**C3** = CONNETTORE PER ELETTROVALVOLA PICCOLO  
SMALL ELECTRO-SOLENOID CONNECTOR

**C4** = CONNETTORE PER ELETTROVALVOLA GRANDE  
BIG ELECTRO-SOLENOID CONNECTOR

**C5** = M12, 90°,  
M12, 90°

**C6** = M12, DIRITTO,  
M12, STRAIGHT

**C3**
**0**
**0**
**00**

### LED/ LED

**00** = NO LED

**02** = 2 LED (PNP - NPN)

### LUNGHEZZA CAVO/ CABLE

**0** = SENZA CAVO/ NO CABLE

### TIPO/ TYPE

**0** = NEUTRO / NEUTRAL

**P** = PNP (C3 - C4 - C5)

**N** = NPN (C3 - C4 - C5)

**\*5** = 5 POLI/ POLES

**\* SOLO PER M12/ M12 ONLY**

## DIMENSIONI MECCANICHE

## MECHANICAL SIZE

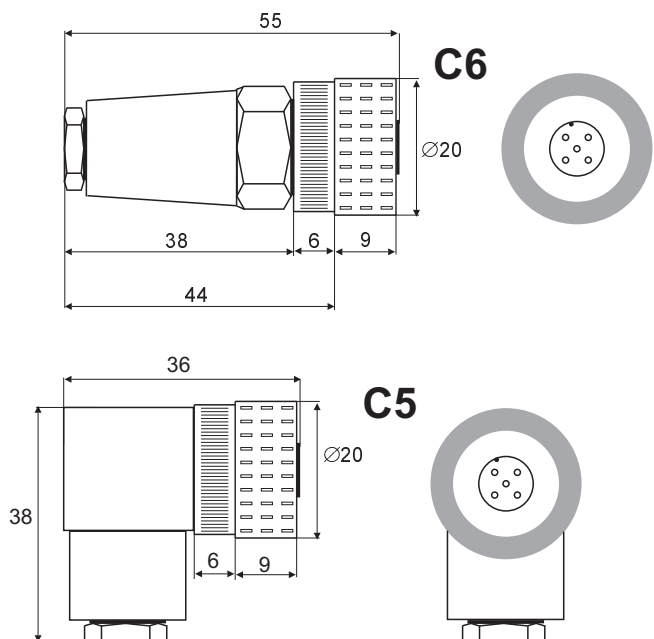
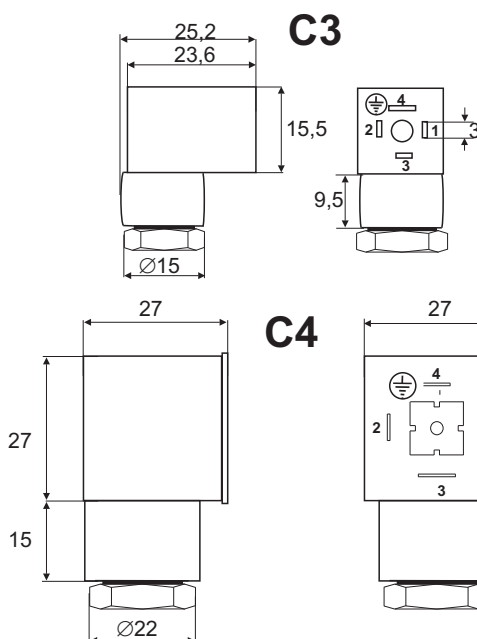

	C3 - C4		C5 - C6			
<b>CORRENTE NOMINALE</b> <i>NOMINAL CURRENT</i>	10 A		4A			
<b>TENSIONE NOMINALE</b> <i>NOMINAL VOLTAGE</i>	250Vca (Senza Led) / 30 Vcc (Con Led) <i>250 Vca (Without Led) / 30 Vcc (With Led)</i>		250 Vca (Senza Led) / 30 Vcc (Con Led) <i>250 Vca (without led) / 30 Vcc (With Led)</i>			
<b>SEZIONE CONDUTTORI</b> <i>WIRE SECTION</i>	3 x 1.5 mm	<sup>2</sup> 4 x 1.5 mm	4 x 1.5 mm <sup>2</sup>	5 x 1.5 mm <sup>2</sup>		
<b>GRADO DI PROTEZIONE</b> <i>IP RATING</i>	IP67		IP67			
<b>TEMPERATURA DI LAVORO</b> <i>OPERATING TEMPERATURE</i>	-25°C ÷ +80°C		-25°C ÷ +80°C			
<b>Senza Led non cablato</b> <i>No Led no cable</i>	<b>C30000</b>	<b>C40000</b>	<b>C50000</b>	<b>C60000</b>	<b>C55000</b>	<b>C65000</b>
<b>PNP 2 Led non cablato</b> <i>PNP 2 Led no cable</i>	<b>C3P002</b>	<b>C4P002</b>	<b>C5P002</b>	-	-	-
<b>NPN 2 Led non cablato</b> <i>NPN 2 Led no cable</i>	<b>C3N002</b>	<b>C4N002</b>	<b>C5N002</b>	-	-	-

**CONNESSIONI**
**CONNECTIONS**
**C3 - C4**  
**SENZA LED, NON CABLATI**

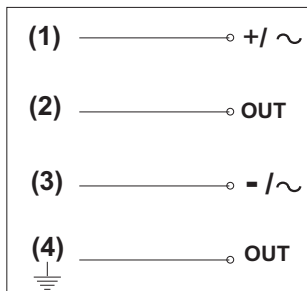
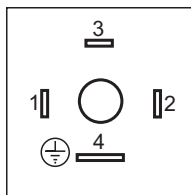
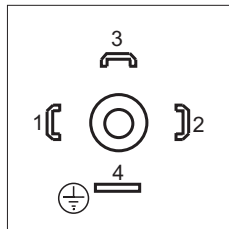
 C3 - C4  
 NO LED, NO CABLE

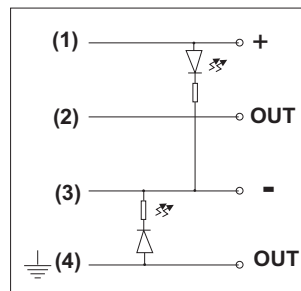
**C3**

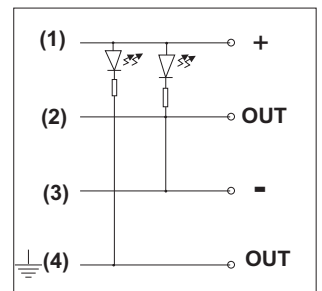
**C4**

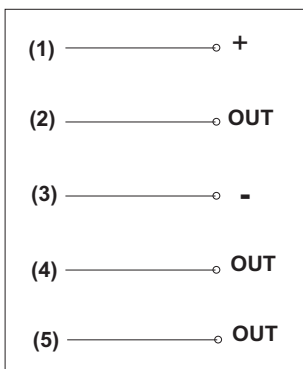
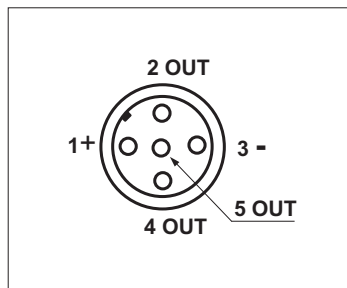
**C3 - C4**  
**PNP CON LED, NON CABLATI**

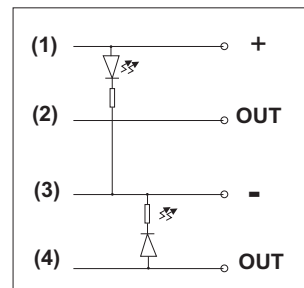
 C3 - C4  
 PNP WITH LED, NO CABLE

**C3 - C4**  
**NPN CON LED, NON CABLATI**

 C3 - C4  
 NPN WITH LED, NO CABLE

**C5 - C6**  
**SENZA LED, NON CABLATI**

 C5 - C5  
 NO LED, NO CABLE

**C5 - C6**

**C5**  
**PNP CON LED, NON CABLATI**

 C5  
 PNP WITH LED, NO CABLE

**C5**  
**NPN, CON LED, NON CABLATI**

 C5  
 NPN, WITH LED, NO CABLE
